



LEOPARD IMAGING INC

LI-AR0231-GMSL2-CFM-xxxH-010

Data Sheet

Key Features

- Compatible with Qualcomm SA8155 platform
- ON SEMI 2.3MP AR0231 Sensor
- Optical format: 1/2.7"
- Pixel size: 3 um x 3 um
- Maximum resolution: 1920H x 1020V
- Frame rate: 28.7fps max
- YUV output without compression
- Includes AP0200 ISP
- Lens: FOV H 57 / 176 / 200
- GMSL2 Serializer
- Powered over GMSL cable
- Connector: FAKRA Z TYPE
- 9V - 19V @ <2W
- Water proof: No
- Operation Temp: -40 ~ 85 °C
- Storage Temp: -40 ~ 105 °C
- Weight: 49 g
- Part#:

LI-AR0231-GMSL2-CFM-xxxH-010



Application

- Automotive ADAS
- ADAS + Viewing Fusion
- Security and Surveillance

Dimensions

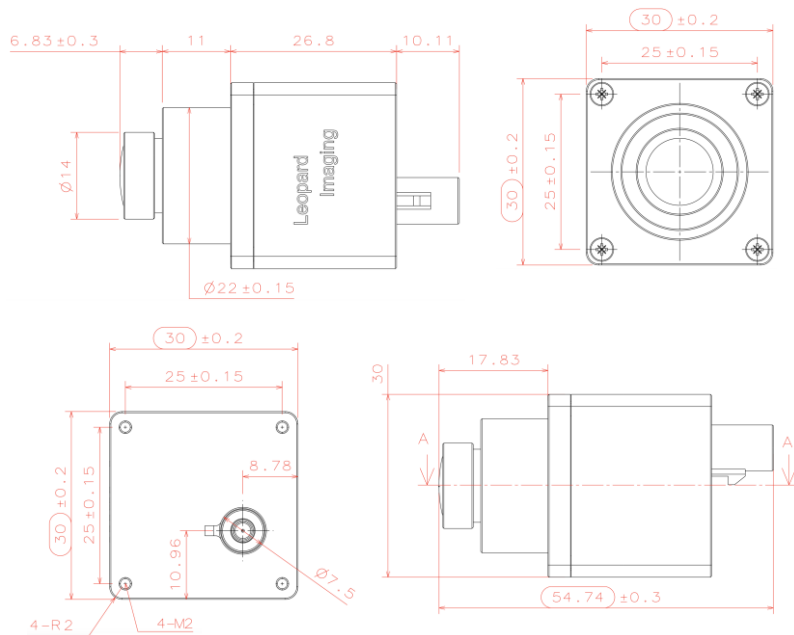

Leopard Imaging Inc.

48820 Kato Road, Suite 100B, Fremont, CA 94538, USA
Phone: +1-408-263-0988
Fax: +1-408-217-1960
Email: sales@leopardimaging.com
Website: www.leopardimaging.com

BOM

#	Name	SPEC	QTY/SET
1	M12 Lens	DSL978 DSL224 F132B0108WM12	1
2	Screw	KM2*8 black STAINLESS 304	4
3	Shell 2	AL6061-T6 BLACK Anodizing	1
4	Sealing ring	Silicon rubber, White	1
5	LI-AR0231-CAM-P-MIPI	AR0231 sensor board	1
6	Copper pillar	M2*5+4	4
7	LI-MAX9295-P-MIPI	GMSL2 board	1
8	O ring	7*2.4 Silicon rubber Red	1
9	Screw	M2*4 black ZINC	2
10	Shell 1	AL6061-T6 BLACK Anodizing	1
13	LI-AP0200-ISP-PAR	AP0200 ISP board	1

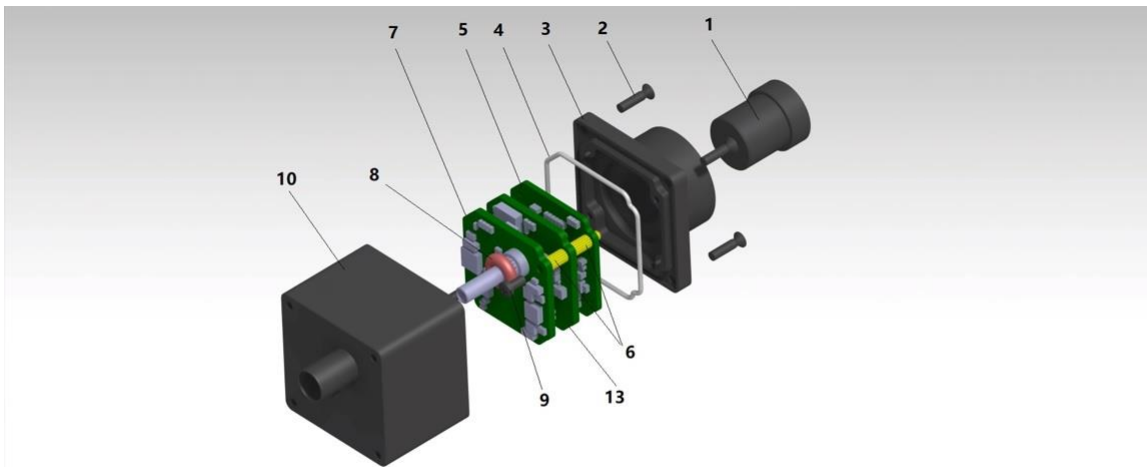

Leopard Imaging Inc.

48820 Kato Road, Suite 100B, Fremont, CA 94538, USA
 Phone: +1-408-263-0988
 Fax: +1-408-217-1960
 Email: sales@leopardimaging.com
 Website: www.leopardimaging.com

Water Proof

- Metal Housing
- Water-proof M12 lens
- Sealed Gasket (White)
- Sealed O-ring (Red)

Note: No water-proof for this camera model since the lens is not glued.

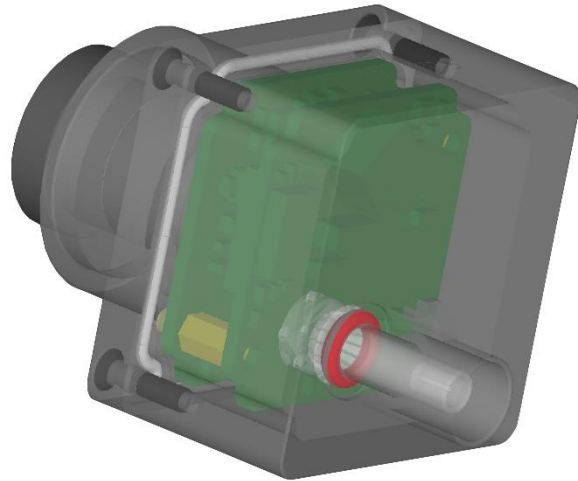

Cable Connector

- Housing Connector- FAKRA Z Type
- Cable length: 3 meters
- Cable Part#: FAK-SMZSMZ-0008
- FAKRA type connectors



Leopard Imaging Inc.

48820 Kato Road, Suite 100B, Fremont, CA 94538, USA
Phone: +1-408-263-0988
Fax: +1-408-217-1960
Email: sales@leopardimaging.com
Website: www.leopardimaging.com

Ordering Information

Part#: LI-AR0231-GMSL2-CFM-xxxH-yyy

- xxx (Lens FOV)
 - o 057
 - o 176
 - o 200
- yyy (- glue/screw, ISP or noISP, IMU or noIMU)
 - o Glue / Screw (lens)
 - 1: Glue
 - 0: Screw
 - o ISP
 - 1: ISP
 - 0: No ISP
 - o IMU
 - 1: IMU
 - 0: No IMU

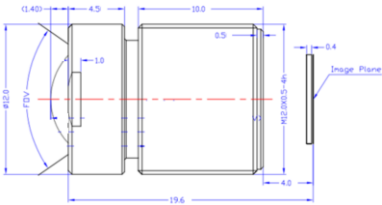
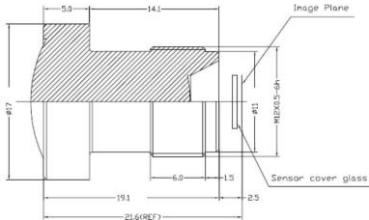
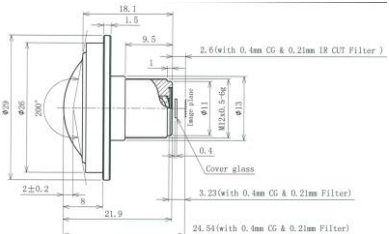
LI-AR0231-GMSL2-CFM-057H-010	LI-AR0231-GMSL2-CFM-176H-010	LI-AR0231-GMSL2-CFM-200H-010
		
<p>Lens: DSL978 Lens EFL: 5.9 mm F/#: 1.6 Distortion: <-15% FOV(H): 57°</p>	<p>Lens: DSL224 Lens EFL: 2.16 mm F/#: 2.0 Distortion: -8.5% FOV(H): 176°</p>	<p>Lens: F132B0108WM12 Lens EFL: 1.08 mm F/#: 2.6 Distortion: <-7.71% FOV(H): 200°</p>



Leopard Imaging Inc.

48820 Kato Road, Suite 100B, Fremont, CA 94538, USA
 Phone: +1-408-263-0988
 Fax: +1-408-217-1960
 Email: sales@leopardimaging.com
 Website: www.leopardimaging.com

Camera Block Diagram

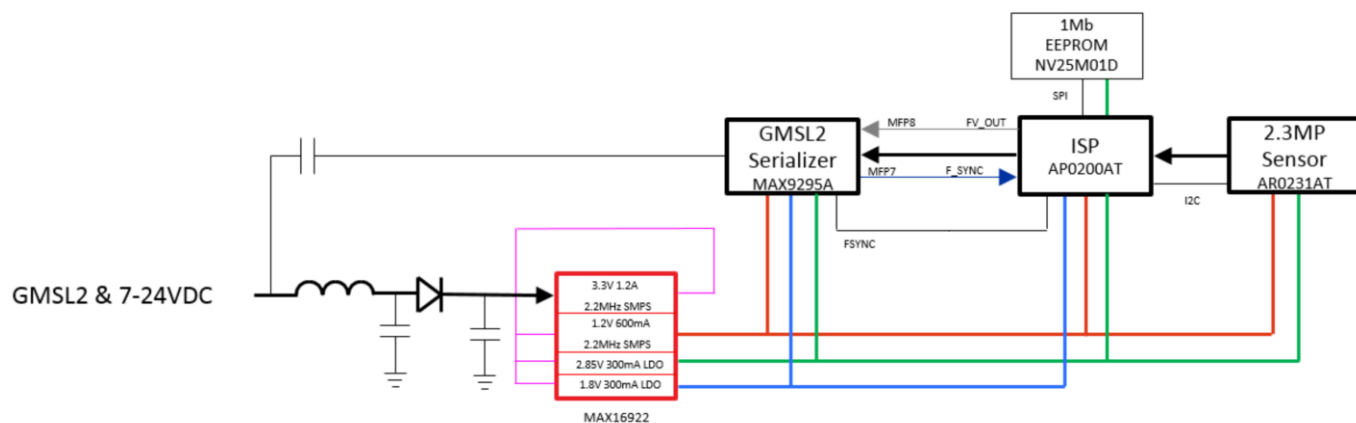

Leopard Imaging Inc.

48820 Kato Road, Suite 100B, Fremont, CA 94538, USA
Phone: +1-408-263-0988
Fax: +1-408-217-1960
Email: sales@leopardimaging.com
Website: www.leopardimaging.com

Revision History

Revision	Description	Release Date
1.0	First Release	19. Oct. 2019



Leopard Imaging Inc.

48820 Kato Road, Suite 100B, Fremont, CA 94538, USA
Phone: +1-408-263-0988
Fax: +1-408-217-1960
Email: sales@leopardimaging.com
Website: www.leopardimaging.com